



# Tyent Australia

www.tyentaustralia.com.au

The user should be responsible for failure or improper selection or improper use of the products such as use in any manner for which the product was not originally intended.

This product is subject to changes that enhance its performance without prior notification.

## pH Chart

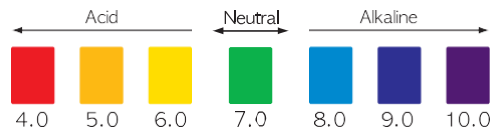

How to Measure: Place 10-15 mL of test water in a container and add 2-3 drops of reagent. Then mix well and check the color of the water with the pH chart above. (The color depends on water quality and reagent.)

If the supply cord is damaged, it must be replaced by the manufacturer, its service agent or similarly qualified persons in order to avoid a hazard.

This appliance is not intended for use by persons (including children) with reduced physical sensory or mental capabilities or lack of experience and knowledge, unless they have been given supervision or instruction concerning use of the appliance by a person responsible for their safety.

Children should be supervised to ensure that they do not play with the appliance.

4/19-21 Bourke Rd, Alexandria NSW 2015.

TEL : 1300 665 636

Website : www.tyentaustralia.com.au

**MADE IN KOREA**



# User Manual

- This product is intended for domestic use only.
- Keep this user manual handy for easy reference.
- Carefully read this User Manual, particularly "all safety warnings."



## To Our Valued Customers

Thank you for purchasing the **NMP series Water Ionizer**. Please read all safety warnings and this User Manual carefully before using this product to ensure proper product usage. (Keep the manual handy for easy reference.)

- We are not responsible for any accidents and/or malfunctions due to the improper use of this machine
- Please keep the manual and warranty card in a safe place, so that it's easily accessible when you need it
- Please refer to this manual often when you have questions when using or when troubleshooting this unit

## Intended Use

This device creates **functional alkaline ionized water**. It changes the properties of regular tap water through the use of electrolysis. Following are the changes normal tap water undergoes via this process:

- An increase or decrease in pH level
- Creation of negatively charged hydrogen ions (antioxidants)
- Purification through filtration

## Table of Contents

To Our Valued Customers .....	2
Table of Contents .....	3
Before Usage .....	4
Safety Precautions and Warnings .....	5
Product Features .....	10
Package Contents .....	12
Unit Overview .....	13
LCD Display and Touch Pad Overview .....	14
How to Install the Unit .....	16
Water Hose Installation .....	18
Directions for Product Use .....	20
System Setup Mode .....	22
Cleaning Function .....	24
Customer Serviceable Parts .....	25
How to Change the Filters .....	26
How to Reset the Filters .....	27
TURBO Function .....	28
Unit Specifications .....	29
Troubleshooting .....	30
Product Warranty .....	31



## Before Usage

Safety precautions are provided for the safe and proper use of this unit and can prevent danger, bodily harm and/or possible damage due to misuse. Please make sure you are familiar with all the safety precautions and warnings associated with this unit.

	<b>DANGER</b> (Red Warning Sign) indicates an imminent hazard that could result in serious injury or death. If you see this sign, stop using this unit immediately.
	<b>WARNING</b> (Orange Warning Sign) indicates a potential hazard that could result in significant bodily harm or damage to the unit. If you see this sign, stop the use of this unit.
	<b>ATTENTION</b> (Yellow Warning Sign) indicates a potential hazard that could result in minor bodily harm or damage to the unit.

1. Do not drink functional water with medication. When taking medication, use “clean H<sub>2</sub>O” filtered water thirty minutes prior to taking medication as well as with medication. You may resume drinking functional water thirty minutes after taking medication.
2. Always consult your primary care physician before drinking functional water. Only drink a small amount near a neutral pH level for the first week. This will give the body time to adjust to functional water during the detoxification period. See Welcome Guide for full details on getting started.
3. If you notice any negative effects from drinking functional water, stop drinking the functional water immediately and consult your primary care physician about changes in your body’s pH level.
4. If you are currently under the care of a primary care physician for an existing condition, consult your primary care physician about how changes in pH and other characteristics of functional water could affect your medical condition.
5. If you suffer from gastric anacidity, kidney failure or potassium excretion, you should not drink functional water.
6. Verify the pH levels of the functional water dispensed from this unit on a monthly basis to ensure proper function. This can be done with the supplied reagent drops and a pH color chart.
7. When switching from one pH to another, it is good practice to let the water run for several seconds before using.
8. It is common to drink half your body weight in ounces. For example, if you weigh 180 pounds, it may be wise to drink 90 ounces every day of water per day. This especially applies after you have given your body some time to adjust to the new pH level.
9. The recommended drinking level for functional water is 9.5 pH (+-0.3). It is not recommended to drink functional water above a pH of 10.
10. If you wish to store functional water, use a glass or other nonleaching material with an airtight lid and store it in the refrigerator. Functional water will begin to weaken immediately and will lose most of its benefits after 3 days.
11. Never run hot water through this unit.
12. Never drink acidic water.

## Safety Precautions and Warnings

### Regarding the Power Supply



Do not use if the power cord is damaged or in a loose power outlet.

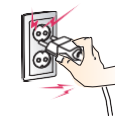

Do not pull the power cord. Never touch the power cord or the power outlet with wet hands.



Do not forcibly bend, squeeze, damage or crush the power cord under heavy objects.



Unplug the power cord during general maintenance, repair and inspection and while replacing parts.

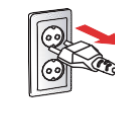

Do not use power surge protectors with this unit. Use unit with its own dedicated power source.

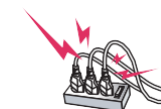



Only use the unit with the correct voltage.



To reduce the risk of electric shock, do not remove the cover; there are no user-serviceable parts inside. Refer servicing to qualified service personnel. Removing the cover will void the warranty.

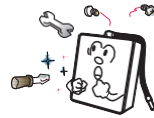

**Installation**

Do not place this unit near heat sources.



Do not place this unit on an uneven surface. Do not drop or use excessive force on this unit.



Do not connect the water line to a hot water supply.

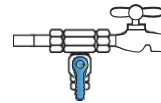

Do not use unfit raw water in accordance with the standards of the water service act.



Do not use in areas of high humidity and/or high temperature.



Install the drain faucet near sink and adjust the position of drain faucet to drain away to the sink.



Make sure the drain faucet is positioned lower than the unit.



If the unit is not used for a few days, let the water run for 1-2 minutes before drinking functional water.



Do not discharge water over 1 hour.



**Usage**

If the unit won't be used for a long time, shut off the valve and unplug the power cord.

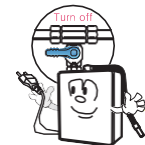

If you hear strange noises, smell a burning odor or see smoke, unplug the power cord immediately and call qualified personnel for service.



Replace filters every 6 months to optimize the purification performance of this unit even if the replacement indicator light isn't turned on.





Do not place any objects on top of this unit no matter how small they are.



If water leaks out of the unit (other than the hoses) or if the unit is standing in a puddle of water, shut off the water supply, unplug the power cord and contact qualified service personnel for service.

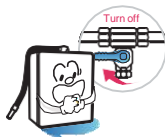

Do not poke or scratch the touch pad or LCD display with sharp objects.



In areas of hard water (calcium scaling present on faucets), notify your service provider and install a cell safe antiscaling prefilter to protect the ionizer from scaling.



Do not use alkaline or acidic water in fish bowls or aquariums. The sudden change in pH could be harmful or fatal to some marine life.



It is beneficial for the maintenance of the machine to run a strong acidic level for 5-minute cycles twice weekly. This will help to maintain a clean chamber.

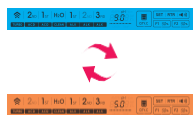

It is normal for condensation to be present on the unit during humid summer months. If condensation persists despite weather conditions, unplug the power cord and refer servicing to qualified service personnel.



Cleaning

Do not store the unit near chemicals, food, metals or medication



benzene or thinner..... Danger

Do not spray water on the main unit. Do not clean the unit with benzene or other chemicals, which may leak into the unit. If using a damp cloth, be very careful not to get electronic display wet.



Storage

Remove the filters and turn them upside down to remove excess water before storing.



If the original packaging is not available, cover the unit in plastic to avoid scratching the surface.



Store the unit in its original packaging in a cool, dry place when not in use.



Carefully remove this unit from its packaging. Keep the original packaging for future storage and unit transportation.





**Product Features**

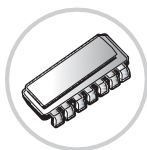

**Fully automatic system with embedded central processing unit (CPU)**  
 Every aspect of creating functional water is controlled by the CPU chip that automatically finds an optimal operating condition using.



**Automatic water flow**  
 Simply pressing the touch button allows you to start and stop the flow of functional water.



**Fixed quantity discharge function**  
 It generates desired amount of water by convenient operation.

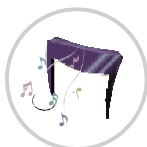

**Voice announcement**  
 Voice announcement for different functions and safety warnings ensure safe and convenient use.



**Filter replacement cycle**  
 This unit features a filter life cycle display and voice announcements designed to let you know when it is time to change the filters. Every 6 months is best for optimal performance.



**Touch LCD display color backlight**  
 The color back light on the LCD display allows you to distinguish alkali water from acidic water.



**Detects if filter door is open**  
 When door is open, the water supply will be suspended for your safety.

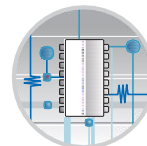

**SMPS type power supply**  
 A CPU monitors the power that is supplied to different parts of the unit, thereby ensuring efficient performance.



**RTR(Real Time Refresh) Automatic cleaning function**  
 Unit features an automatic plate cleaning function using polarity oscillation.



**Automatic Stop Function**  
 15 minutes after a function is selected, water outflow will stop to prevent overflow or flooding.

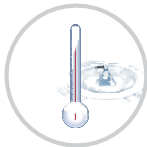

**Temperature Sensor Function for Safe Operation**  
 If the temperature of the source water exceeds 95°F (35°C) then water will stop flowing and a warning message will appear on the screen.



**Eco mode**  
 The LCD backlight will be turned off automatically during periods of non-use and the Time function is displayed.

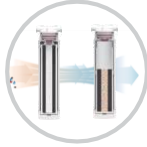

**Advanced water purification system**  
 The advanced performance of the primary filter and functional secondary filter enable optimal purifying conditions for tap water.

**Safety Functions**

The outflow of functional water stops automatically when raw water is not supplied, preventing the electrolytic cell and power supply unit from being damaged due to current overflow, water from being wasted and accidental water leaks. This function also allows you to set pH and ORP levels according to the amount of water inflow, to distinguish pH from backlight colors and set the auto cleaning function.





## Package Contents

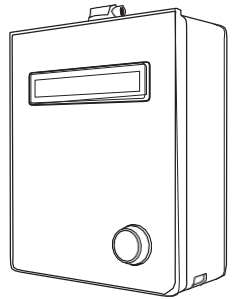

Water Ionizer

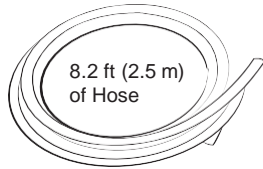

8.2 ft (2.5 m)  
of Hose

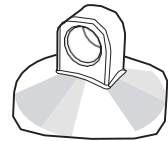

Tube Suction Cup



Water Outlet Tube

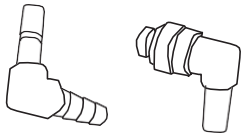

Tube Elbow Stem Elbow

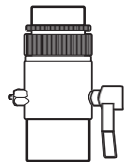

Faucet Diverter

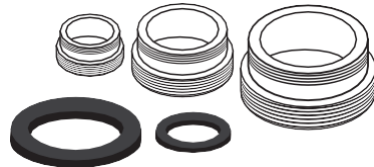

Assortment of Connectors  
and Rubber Washers

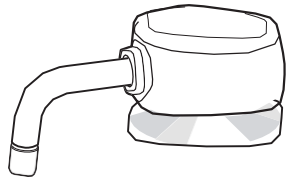

Drain Faucet



pH Testing  
Solution Bottle

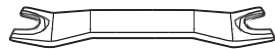

Wrench

- Drain Hose
- User Manual

### Tools You Will Need



Utility  
Scissors

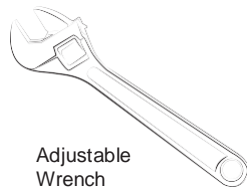

Adjustable  
Wrench

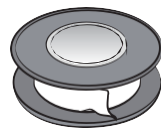

Plumber's  
Tape

## Unit Overview

Make sure you are familiar with the parts and features of this unit, and carefully read the user manual and other important information

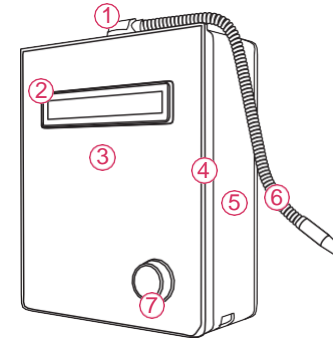

### Front View

- ① Water Outlet Unit
- ② LCD Display
- ③ Front Cover
- ④ Door Case
- ⑤ Front Case
- ⑥ Water Outlet Tube
- ⑦ JOG Dial

(Model: NMP-9000T, S11T, S13T)

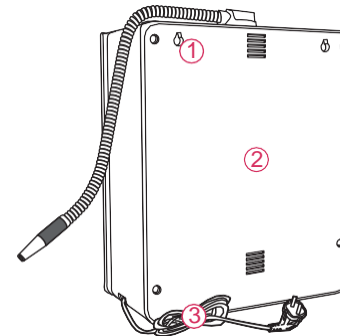

### Rear View

- ① Hanging Groove
- ② Rear Case
- ③ Power Cord

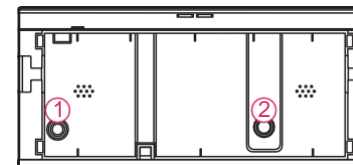

### Bottom View

- ① Water Inflow
- ② Water Outflow



# LCD Display and Touch Pad Overview

## 1 Standby screen

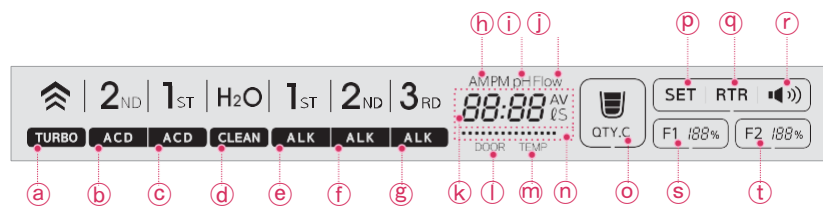

a	Turbo	h	Time	o	Fixed quantity discharge
b	Acidic level 2	i	pH	p	System set up
c	Acidic level 1	j	Water flow	q	Cleaning
d	Purify water	k	Voltage/Flow/Time	r	Volume On / Off
e	Alkaline level 1	l	Door open	s	1st Filter reset
f	Alkaline level 2	m	Temperature	t	2nd Filter reset
g	Alkaline level 3	n	Remaining time		

## 2 Water Outflow screen

The selected icon flickers during water outflow.



Below information will be rotating on the display.

Selected pH level

Amount of supply water

Remaining discharge time

## 3 Display color

When Alkaline Water (1, 2 & 3), Purified Water (H<sub>2</sub>O), Acidic Water (1 & 2) and Turbo Water icons are selected, backlight colors are as follows :



**Alkaline level 1**  
Light Alkaline water



**Alkaline level 2**  
Medium Alkaline water



**Alkaline level 3**  
Strong Alkaline water



**Purify water**  
Creates purified water



**Acidic level 1**  
Non-Drinkable



**Acidic level 2**  
Non-Drinkable



**Turbo mode**  
Non-Drinkable



**Real Time Refresh**  
Non-Drinkable

※pH value is standard value based on test water.

※Errors may occur between actual output water according to raw water condition such as water quality, amount of water and temperature.

Backlight of LCD display will match the pH level color according to water pH level being used after icon is pressed.





## How to Install the Unit

Determine whether you will connect the unit directly to the cold water supply line (under sink) or to the faucet (see image).

- **Option A | Faucet:** A faucet connection requires a faucet diverter (included).
- **Option B | Under-Sink:** An under sink connection requires an under-sink adapter kit (not included) or a compatible t-valve (available from most hardware stores). For more information see Welcome Guide or call support.

### Option A – Faucet Installation

Many faucets vary in design, and your faucet may require different setup instructions than those featured in this manual. Please consult a qualified service professional if you are unable to correctly complete the installation.

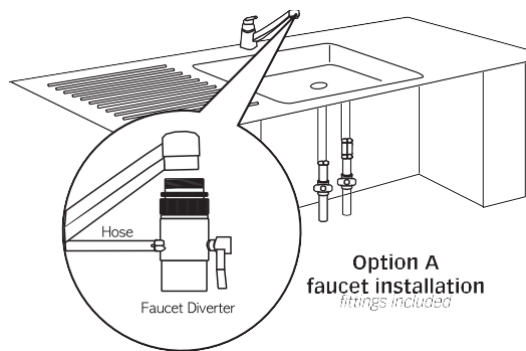

- 1 Shut off both the hot and cold water main supply at the pipe under the sink.
- 2 If your faucet features a screw-on style aerator, remove it by unscrewing it from the tip of the faucet.
- 3 If the included faucet diverter does not fit directly to the tip of the faucet, select an appropriate size connector and rubber washer (included).
- 4 When connecting the diverter or adapter to the faucet, be sure to use plumbing pipe thread seal tape (not included) to prevent leaks.
- 5 If necessary, connect the faucet diverter with the appropriate connector to the faucet.
- 6 Be sure all connections are secure but do not overtighten them.

### Option B – Under-Sink Installation

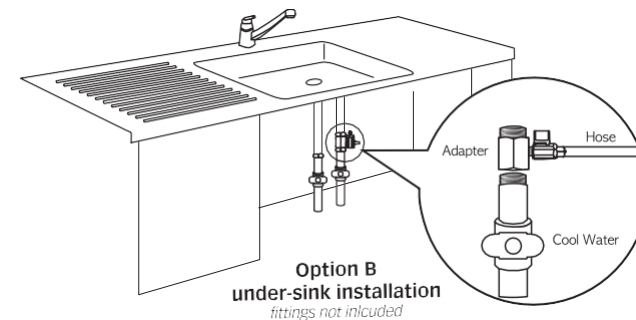

- 1 Purchase either an under-sink installation kit (not included) or purchase a T-connection (with shut-off valve) from a hardware or plumbing supply store.
- 2 Shutoff both the hot and cold water main supply at the pipe under the sink.
- 3 Locate the cold water supplyline valve.
- 4 Disconnect the faucet cold water supply line from main cold water pipe. Use a towel to catch the small amount of water that may come from the faucet supply line.
- 5 When connecting the T-connection to cold water pipe, be sure to use plumbing pipe thread seal tape (not included) to prevent leaks.
- 6 Reconnect the faucet cold water supply line to the T-connection (now secured to the main cold water pipe).
- 7 Be sure all connections are secure but do not overtighten them.

#### Both Options

Do not turn on the main water supply until all hoses are properly installed to the unit. The unit and components are subject to change without prior notification in order to enhance performance.



## Water Hose Installation

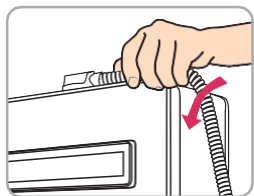

- ① Place the unit on the planned installation location and screw the flexible tube clockwise into the water outlet hole positioned at the top of the unit. Do not over tighten.

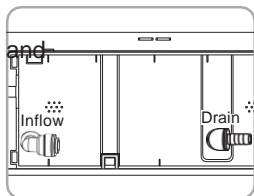

- ② Press the stem elbows into the water inflow/outflow holes on the bottom of the unit until you hear a click and feel the hose sit firmly in place.

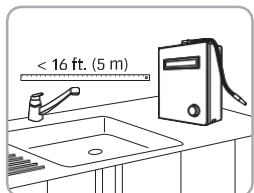

- ③ Measure between where the unit will be located (on the counter) and the water faucet (or under-sink T-connection) where the diverter (or T-connection) will be installed. Cut enough hose to allow connection from the rear of the unit to the water supply (either faucet diverter or under-sink T-connection).

**Note:** Keep the length under-16 feet (5 meters) from the unit to the faucet. You may need a pressure pump or larger size hose if the pressure is too low. Be sure to leave a few extra inches (centimeters) of length so the faucet can still be rotated.

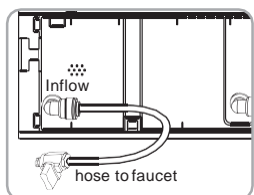

- ④ Connect the hose from the inflow hole to the cold water supply, either at the faucet diverter (Option A - remove the nut from the diverter, slide the nut on to the hose, firmly seat the hose on the faucet diverter, and screw the nut over the hose and back on to the faucet diverter) or the under-sink T-connection.

(**Option B:** route the hose through the counter-top to the T-connection, firmly seat the hose on the T-connection, make sure the connection is sealed completely)

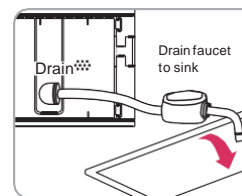

- ⑤ Cut an appropriate length of drain hose and connect it the drain faucet. When drain hose is connected, put the drain faucet in the inner part of sink to run water.



- ⑥ Install the drain faucet near sink and adjust the position of drain faucet to drain away to the sink.

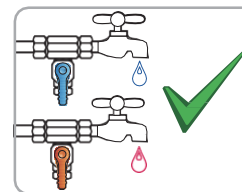

- ⑦ Turn on both the cold and hot water supply. Make sure there are no leaks at any of the connections. Make sure the faucet is working with both hot and cold water. Make sure there are no leaks from the hose connections on the bottom of the unit. Make sure the hoses are firmly seated in the unit holes.

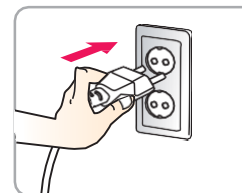

- ⑧ Plug in the power cord. You should hear a series of tones when you power up the unit.

※ Be careful not to touch the touch screen at initial power up. The touch sensor may not operate caused by touch sensibility change. If the touch sensor does not operate due to contact with a part of the body, reconnect the power cord.



## Directions for Product Use

### 1 When using the Touch screen



- ① Select a desired water mode.
- ② Water Outflow: The selected icon flickers during water outflow. If the selected icon is not pressed again, the unit will automatically stop after 15 minutes of water outflow.
- ③ Water Outflow Stop: Lightly touch the blinking icon again to stop water flow.  
※NOTE: Remember, a LIGHT TOUCH is all that is required when pressing the LCD.

### When using fixed quantity discharge function



- ① Touch the QTY,C icon and choose a fixed amount of water. (0.5ℓ, 1.0ℓ, 1.5ℓ) (0.5 » 1.0 » 1.5 » release )
- ② Select a desired water mode.
- ③ Water outflow stops automatically.  
(Fixed quantity discharge function is released after water comes out.)

### 2 When using the Jog dial

(model: NMP-9000T, S11T, S13T)

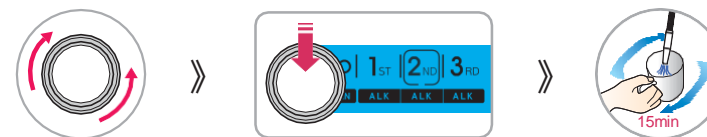

- ① Turn Dial either direction to select function.
- ② Push center of Dial to start water outflow. The selected icon flickers during water outflow.
- ③ Push center of Dial to stop water outflow.

### When using fixed quantity discharge function

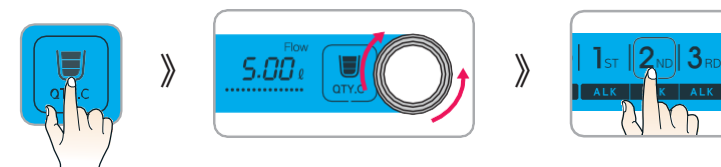

- ① Touch the "QTY,C" button.
- ② Select the fixed amount of water you need by turning the jog dial.
  - Clockwise : Increasing by 100ml (Max.5L )
  - Counterclockwise : Decreasing by 100ml (Min. 200ml )
- ③ Push the discharge level you need.
- ④ Automatic stop after discharging fixed amount of water you selected.  
(Discharge of water will stop when you touch the button while water is coming out.)
- ⑤ After water comes out, fixed quantity discharge function is released.



# System setup mode

## 1 Setting the time



① Change to the system setting mode by pressing the SET icon on the LCD for 3 seconds. (beeps 2 times. Voice says ,“System setup mode”)



② Press the fixed quantity discharge icon for 3 seconds. (beeps 2 times)

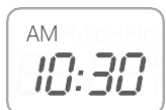

③ The mode (AM-Hour-Minute) will be changed by selecting the fixed quantity discharge icon in this sequence.

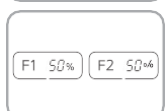

④ Press F1 or F2 to set the time. (Adjustable by Jog dial)



⑤ Once setup is complete, press the fixed quantity discharge icon for 3 seconds. (beeps 2 times)



⑥ Push setup icon for 3 seconds to return to standby screen. (beeps 2 times. Voice says ,“Setup was completed”)

## 2 pH ControlFunction



① Change to the system setting mode by pressing the SET icon on the LCD for 3 seconds. (beeps 2 times. Voice says ,“System setup mode”)

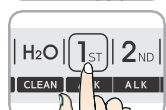

② Press the desired water level button for 3 seconds. (beeps 2 times)

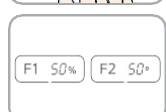

③ Press F1 to raise pH. Press F2 to lower pH. (Adjustable by Jog dial)

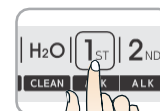

④ Once setup is complete, press the water level button you selected for 3 seconds. (beeps 2 times)



⑤ Push setup icon for 3 seconds to return to standby screen. (beeps 2 times. Voice says ,“Setup was completed”)

## 3 Volume Level Adjustment



① Change to the system setting mode by pressing the SET icon on the LCD for 3 seconds. (beeps 2 times. Voice says ,“System setup mode”)



② Press the voice icon to control volume.

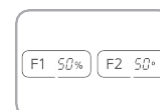

③ Control the voice volume by F1 and F2 button on the bottom. Current voice volume level is displayed on LCD.  
- F1 icon : Volume decrease  
- F2 icon : Volume increase

④ Push setup icon for 3 seconds to return to standby screen. (beeps 2 times. Voice says ,“Setup was completed”)

## 4 Selecting Voice On /Off



① The voice icon will disappear by selecting the voice icon in this sequence.  
② Voice message - On : “ Voice function works ”  
Off : “ Voice function terminates ”



## Cleaning Function

### 1 Auto Cleaning Function (15 Sec)



- ① Performed during water outflow after more than 12 hours of non-operation.  
(Note: RTR icon and backlight will flicker before automatic cleaning is performed)
- ② Performed after 30 liters of water outflow. Performed each time power is turned on.  
(Note: RTR icon and backlight will flicker before automatic cleaning is performed)

### 2 Manual Cleaning Function (15 Sec)



- ① Press the RTR button on stand-by screen.
- ② The cleaning (Voice message: "It's under washing, do not drink")
  - Automatic stop: The cleaning will be stop automatically when the washing time is done.
  - Manual stop: The cleaning will be stop when touching the screen during under washing
- ③ The screen changes to the standby screen once the cleaning is done.

## Customer Serviceable Parts

ATTENTION: The consumer accepts any and all responsibility and/or liability if replacement filters and/or purchased parts are not manufacturer specific. This unit contains high-performance purifying filters and an advanced control system.



Primary Filter: YT20 1st Filter

Recommended filter replacement cycle:  
951.0 gallons (3,600 L)/ Every 6 months

Removes harmful chemicals like chlorine, compounds such as agrichemicals and detergents, large suspended matters like rust and sediments as well as other volatile organic compounds through an efficient, an activated absorption method. It also eliminates bad smells and any remaining dissolved chlorine.



Secondary Filter: YT20 2nd Filter

Recommended filter replacement cycle:  
951.0 gallons (3,600 L)/ Every 6 months

Fine artificial film filters contaminated materials including ordinary bacteria while maintaining essential minerals in the water.

The life of the filter can vary greatly due to use, water pressure, water quality and the changing of the seasons. Filters may need to be replaced sooner than the scheduled time due to these reasons, you may notice reduced water quality or declining water taste.



## How to Change the Filters

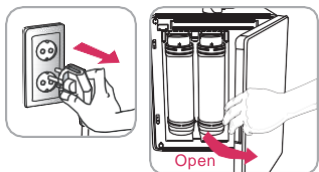

- ① Shut off the water supply to the unit. Turn the power off and unplug the power cord. Open the door in front of the product.

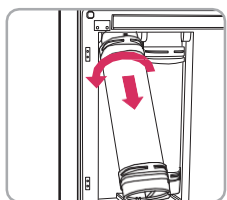

- ② Raise the filter to be replaced and turn it counter clockwise to remove it.

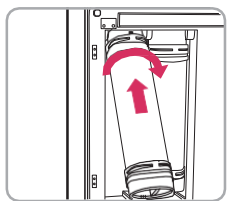

- ③ Put the new filter into the right position by turning it clockwise.

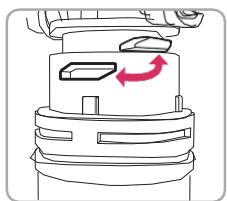

- ④ When installing the filter, the connection bump of the head and the connection groove on the top of the filter should be completely combined.

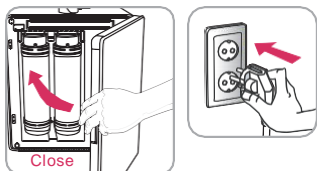

- ⑤ Close the door, plug the power cord back in, reengage the water supply and switch the unit back on.

After initializing the filter, press the H<sub>2</sub>O button and run purified water for 3 minutes. You are highly recommended to follow this process to use the machine properly.

## How to Reset the Filters

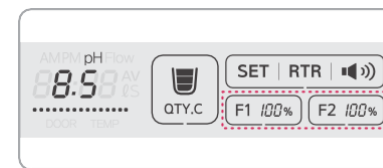

- ① Replace the target filter.
- ② After replacing the filter, press the F1 icon for 3 seconds. Selected filter is initialized and beeps twice. Voice announcement : "1st Filter / initializing was performed."
- ③ Next, press the F2 icon for 3 seconds. Selected filter is initialized and beeps twice. Voice announcement : "2nd Filter / initializing was performed."
- ④ Filter usage is displayed in 0 percent(0%) when the filter is initialized properly.
- ⑤ The water outflow selection mode is available for operation.



Unless the quantity filtered is reset, the corresponding filter replacement message keeps responding.





## Turbo Function

The TURBO function allows you to create strong alkaline and strong acidic water. These types of waters are ONLY to be used for cleaning, sanitizing, and disinfecting purposes. **NEVER DRINK THESE TYPES OF WATER.**

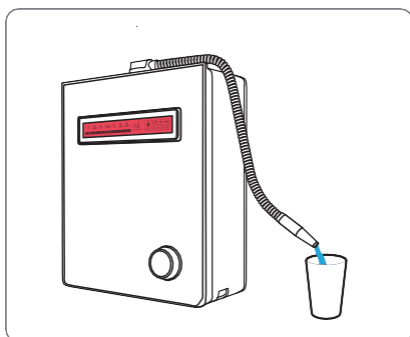
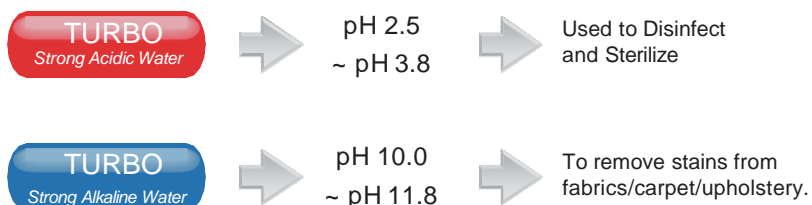

Alkaline Turbo Water Outflow

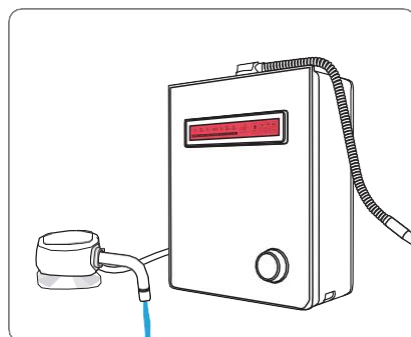

Acidic Turbo Water Outflow

- The waters produced in TURBO mode are not intended for drinking. **DO NOT DRINK** these types of waters.
- **DO NOT** Use the TURBO function in a manner other than directed.
- While operating the TURBO function, the machine will automatically stop dispensing water after 5 minutes. This feature prevents accidental overflow or flooding.

## Unit specifications

Model Number	NMP-5000T	NMP-7000T	NMP-9000T	NMP-S11T	NMP-S13T
Electrolytic Cell Quantity of Poles	5	7	9	11	13
Power Consumption	Max 220W				
TURBO Function	O				
Product Name	Water Ionizer				
Rated Voltage	100 -130 V~ <input type="checkbox"/> , 200 -240 V~ <input checked="" type="checkbox"/> / 50-60 Hz				
Available temperature	4 -35°C (39 -95°F)				
Operating Pressure Range	0.1- 0.5 MPa				
pH Levels	3 Alkaline, 1 Neutral, 2 Acidic, Turbo				
Adjustable pH	User adjustable pH levels control				
Filters Configuration	2 Filters System				
Filter Life Display	LCD filter replacement and announcement				
Water Cell Plate Materials	Platinum and Titanium				
Product Size	W300 x D135 x H355 mm (11.8 x 5.3 x 13.9 inches)				
Product Weight	approx 5.0kg (11.1 Lbs )				

※To make the best functionality, there may be some change without notices.



# Troubleshooting

Symptoms	Checkpoints	Measures to be Taken
Abnormal Taste	Check period of use.	Run unit for one minute, draining stagnant water.
	Check filter for replacement time.	Replace filter.
	Check if valve on water supply is closed.	Open Valve.
Water Outflow Change	Check if hose is bent or folded.	Stretch out hose.
	Check if flow rates are low. (less than 14/min.)	Contact us to install water pump.
	Check if water supply is cut ou or if the water supply line is frozen.	Wait until water comes out of the water supply pipe.
	Check filters for clog.	Change filter.
Incorrect pH levels	Check water for solidity.	Water quality varies byregion.
	Check flow rates for higher levels.	Reduce amount of raw water.
Filter replacement icon remains "on" even after filter has been replaced	Check if amount of drained water is small.	Contact us. Request after-saleservice.
	Check if the filter flow rate is initiated.	Initialize filter flow rate. (System setting mode.) or Request service
Unit stops duringuse.	Check if the operating time exceeds 15 min. ※Turbo :5 min	Unit stops automatically after 15 min.
	Check filter for propermounting.	
Unit leaks.	Check filter for propermounting.	Unplug unit. Contact us.
	Check other areas of unit.	
Settlement in extracted water.	Check for excessive calcium in source water.	Contact us for additional filter.
Only purified water is extracted.	Check if flow rate is high. (5kgf/cm <sup>2</sup> or faster.)	Contact us to install a pressure reducing valve.
	Check if amount of working water exceeds 30L	
The Unit doesn't not operate in cleaning mode.	Check if operating time exceeds 12 hrs.	The unit returns to normal after performing auto cleaning for 15 seconds.
	Check if cleaning icon is pressed.	
The screen turnsou.	Check if non-operating time exceeds 10 minutes.	When non-using the unit for 10 minutes, it changes to the ECO mode automatically. The unit returns to normal after touching the screen.

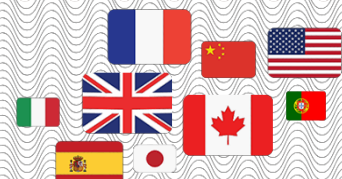

## Various Languages

# Multiple Languages Supported

Diversified language guide support is available by selecting 1 out of **5 languages** featured. **English, Chinese, German, French, Italian**



Tyent Water is the First People choice all around the World









# Thank you

**Tyent Australasia PTY LTD**

4/19-21 Bourke Rd, Alexandria NSW 2015.

TEL : 1300 665 636

Website : [www.tyentaustralia.com.au](http://www.tyentaustralia.com.au)